

USER'S MANUAL

AXIS M7001 Video Encoder



Notices

This manual is intended for administrators and users of the AXIS M7001 Video Encoder, and is applicable for firmware release 5.00 and later. It includes instructions for using and managing the encoder on your network. Previous experience of networking will be of use when using this product. Some knowledge of UNIX or Linux-based systems may also be beneficial, for developing shell scripts and applications. Later versions of this document will be posted to the Axis Website, as required. See also the product's online help, available via the Web-based interface.

Liability

Every care has been taken in the preparation of this manual. Please inform your local Axis office of any inaccuracies or omissions. Axis Communications AB cannot be held responsible for any technical or typographical errors and reserves the right to make changes to the product and manuals without prior notice. Axis Communications AB makes no warranty of any kind with regard to the material contained within this document, including, but not limited to, the implied warranties of merchantability and fitness for a particular purpose. Axis Communications AB shall not be liable nor responsible for incidental or consequential damages in connection with the furnishing, performance or use of this material.

Intellectual Property Rights

Axis AB has intellectual property rights relating to technology embodied in the product described in this document. In particular, and without limitation, these intellectual property rights may include one or more of the patents listed at <http://www.axis.com/patent.htm> and one or more additional patents or pending patent applications in the US and other countries.

This product contains licensed third-party software. See the menu item "About" in the product's user interface for more information.

This product contains source code copyright Apple Computer, Inc., under the terms of Apple Public Source License 2.0 (see <http://www.opensource.apple.com/apsl/>). The source code is available from: <http://developer.apple.com/darwin/projects/bonjour/>

Equipment Modifications

This equipment must be installed and used in strict accordance with the instructions given in the user documentation. This equipment contains no user-serviceable components. Unauthorized equipment changes or modifications will invalidate all applicable regulatory certifications and approvals.

Trademark Acknowledgments

Apple, Boa, Bonjour, Ethernet, Internet Explorer, Linux, Microsoft, Mozilla, Netscape Navigator, OS/2, Real, QuickTime, UNIX, Windows, WWW are registered trademarks of the respective holders. Java and all Java-based trademarks and logos are trademarks or registered trademarks of Sun Microsystems, Inc. in the United States and other countries. Axis Communications AB is independent of Sun Microsystems Inc. UPnP™ is a certification mark of the UPnP™ Implementers Corporation.

Support

Should you require any technical assistance, please contact your Axis reseller. If your questions cannot be answered immediately, your reseller will forward your queries through the appropriate channels to ensure a rapid response. If you are connected to the Internet, you can:

- download user documentation and firmware updates
- find answers to resolved problems in the FAQ database. Search by product, category, or phrases
- report problems to Axis support by logging in to your private support area
- visit Axis Support at www.axis.com/techsup

Notices	2
Product Description	4
Key features	4
Overview	5
LED indicators	5
Using the Video Encoder	6
Access from a browser	6
Access from the Internet	7
Setting the root password	7
The Live View page	8
Video Streams	9
How to stream H.264	9
Motion JPEG	10
AXIS Media Control (AMC)	10
Alternative methods of accessing the video stream	10
Video Settings	11
Video Stream	11
Stream Profiles	12
Camera Settings	12
Privacy Mask	13
Live View Config	14
Layout	14
Event Configuration	16
Event Servers	16
Event Types	16
Motion Detection	19
Pan Tilt Zoom	21
Installing PTZ devices	21
PTZ Configuration	22
PTZ Controls	25
System Options	27
Security	27
Date & Time	28
Network	28
Ports & Devices	32
LED	32
Maintenance	32
Support	33
Advanced	34
About	34
Resetting to the Factory Default Settings	34
Unit connectors	35
LED indicators	36
Troubleshooting	37
Checking the Firmware	37
Upgrading the Firmware	37
Symptoms, Possible Causes, and Remedial Action	39
Technical Specifications	41
General performance considerations	42
Optimizing your system	42
Glossary	43
Index	46

Product Description

This manual applies to the AXIS M7001 Video Encoder.

Key features

- **Compact, cost-effective solution**
Palm-sized and with a discreet design at a competitive price, AXIS M7001 provides an easy and cost-effective solution for integrating small or large numbers of analog cameras into an IP-based video surveillance system.
- **Full frame rate in all resolutions**
AXIS M7001 can deliver 30/25 fps (NTSC/PAL) in all resolutions up to D1 (720x480/576).
- **Simultaneous H.264 and Motion JPEG**
AXIS M7001 delivers two simultaneous streams in full frame rate at the highest resolution, one in H.264 and one in Motion JPEG.
- **PTZ support**
Four-wire, RS-422/485 support for PTZ and PTZ dome cameras.
- **Power over Ethernet**
AXIS M7001 is powered over Ethernet (PoE) with power feed to the optional covert camera.

Overview

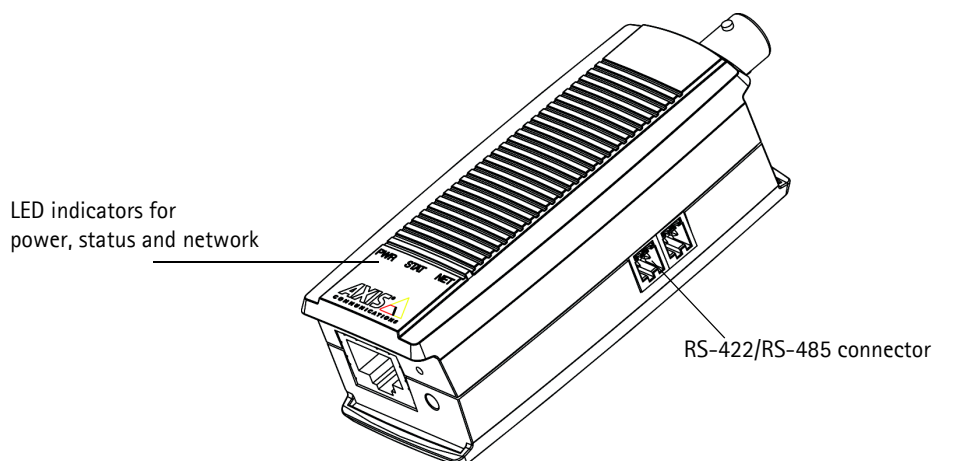

2.5 mm tele plug connector

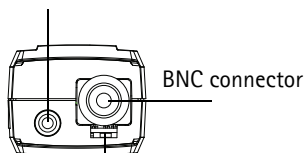

75 Ohm termination switch

Network connector (PoE class 2)

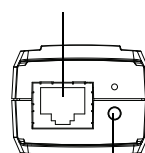

Product label includes:
Product ID & Serial number (S/N).
The serial number may be required during the installation.

LED indicators

LED	Color	Indication
Network	Green	Steady for connection to a 100 Mbit/s network. Flashes for network activity.
	Amber	Steady for connection to 10 Mbit/s network. Flashes for network activity.
	Unlit	No network connection
Status	Green	Steady green for normal operation.
	Amber	Steady during startup, during reset to factory default or when restoring settings.
	Red	Slow flash for failed upgrade.
Power	Green	Normal operation.
	Amber	Flashes green/amber during firmware upgrade.

The LED indicators can be disabled, see page 32. Disabling the LEDs can be useful in covert surveillance situations.

Using the Video Encoder

Please refer to the Installation Guide supplied with the product in order to install the AXIS M7001 Video Encoder.

The AXIS M7001 can be used with most standard operating systems and browsers.

Notes:

- To view streaming video in Internet Explorer, set your browser to allow ActiveX controls and install AXIS Media Control (AMC) on your workstation.
- QuickTime™ is also supported for viewing streaming H.264 video.
- If your workstation restricts the use of additional software components, the video encoder can be configured to use a Java applet for viewing Motion JPEG.
- The video encoder includes one (1) decoder license for viewing H.264 video streams. This is automatically installed with AXIS Media Control. The administrator can disable the installation of the H.264 decoder, to prevent installation of unlicensed copies.

Access from a browser

1. Start a browser (Internet Explorer, Firefox).
2. Enter the IP address or host name of the encoder in the **Location/Address** field of your browser. To access the video encoder from a Macintosh computer (Mac OSX), click on the Bonjour tab and select the AXIS M7001 from the drop-down list.
3. If this is the first time you are accessing the AXIS M7001, see *Setting the root password*, on page 7. Otherwise enter your user name and password, set by the administrator.
4. The encoder's Live View page appears in your browser.

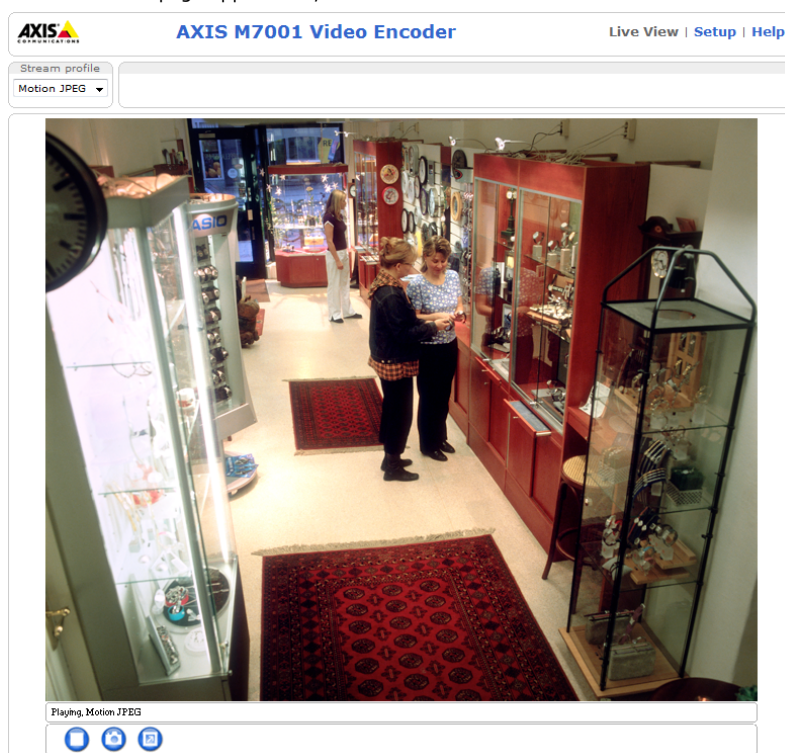

Note:

The layout of the Live View page may have been customized to specific requirements. Consequently, some of the examples and functions featured here may differ from those displayed on your Live View page.

Access from the Internet

Once connected, the video encoder is accessible on your local network (LAN). To access the video encoder from the Internet you must configure your broadband router to allow incoming data traffic to the video encoder. To do this, enable the NAT-traversal feature, which will attempt to automatically configure the router to allow access to the video encoder. This is enabled from Setup > System Options > Network > TCP/IP Advanced.

For more information, please see *NAT traversal (port mapping) for IPv4*, on page 30. See also the AXIS Internet Dynamic DNS Service at www.axiscam.net For Technical notes on this and other topics, visit the Axis Support web at www.axis.com/techsup

Setting the root password

To gain access to the product, the password for the default administrator user root must be set. This is done in the 'Configure Root Password' dialog, which is displayed when the video encoder is accessed for the first time. To prevent network eavesdropping, the root password can be set via an encrypted HTTPS connection, which requires an HTTPS certificate.

Note:

HTTPS (Hypertext Transfer Protocol over SSL) is a protocol used to encrypt the traffic between web browsers and servers. The HTTPS certificate controls the encrypted exchange of information.

To create an HTTPS connection, start by clicking this button.

To configure the password directly via an unencrypted connection, enter the password here.

To set the password via a standard HTTP connection, enter it directly in the **Configure Root Password** dialog.

To set the password via an encrypted HTTPS connection, follow these steps:

1. Click the **Create self-signed certificate** button.
2. Provide the requested information and click **OK**. The certificate is created and the password can now be set securely. All traffic to and from the video encoder is encrypted from this point on.
3. Enter a password and then re-enter it to confirm the spelling. Click **OK**. The password has now been configured.

Notes:

- The default administrator user name 'root' is permanent and cannot be deleted.
- If the root password is lost, the video encoder must be reset to the factory default settings, see page 34.
- If prompted, click **Yes** to install the AXIS Media Control, which allows viewing of the video stream in Internet Explorer. You will need administrator rights on the computer to do this.

The Live View page

If the video encoder has been customized to meet specific requirements, the buttons and other items described below may or may not be displayed on the Live View page. The following provides an overview of each available button:

General controls



The **Stream Profile** drop-down list allows you to select a customized or pre-programmed stream profile on the Live View page. Stream profiles are configured under **Setup > Video > Stream Profiles**, see *Stream Profiles*, on page 12 for more information.



The Manual **trigger** buttons can trigger an event directly from the Live View page. These buttons are configured under **Events**.



The **Snapshot** button saves a snapshot of the video image currently on display. Right-click on the video image to save it in JPEG format on your computer. This button is primarily intended for use when the AXIS Media Control viewer toolbar is not available.

AXIS Media Control toolbar

The AXIS Media Control viewer toolbar is available in Internet Explorer only. See *AXIS Media Control (AMC)*, on page 10 for more information. The toolbar displays the following buttons:



The **Play** button connects to the Axis product and starts playing a media stream.



The **Stop** button stops the video stream being played.



The **Snapshot** button takes a snapshot of the current image. The location where the image is saved can be specified using the AMC Control Panel.



Click the **View Full Screen** button and the video image will fill the entire screen area. No other windows will be visible. Press **Esc** (Escape) on the computer keyboard to cancel full screen view.



The **Record** button is used to record the current video stream. The location where the recording is saved can be specified using the AMC Control Panel.

Pan/Tilt/Zoom controls

If a PTZ device is installed, the Live View page also displays controls for the PTZ device. See *PTZ Controls*, on page 25 for more information.

Video Streams

The video encoder provides several image and video stream formats. Your requirements and the properties of your network will determine the type you use.

The Live View page in the video encoder provides access to H.264 and Motion JPEG video streams, and to the list of available stream profiles. Other applications and clients can also access these video streams/images directly, without going via the Live View page.

Simultaneous video streams

The AXIS M7001 Video Encoder supports simultaneous streaming of one H.264 stream and one Motion JPEG stream, individually configured with different resolutions, bit rates, compression levels etc. The error message "503 service unavailable" is shown if the maximum number of simultaneous streams is exceeded, for example if a user requests a Motion JPEG stream while another user is accessing Motion JPEG video with a different stream configuration.

How to stream H.264

The H.264 video compression standard makes good use of bandwidth, and can provide high quality video streams at less than 1 Mbit/s.

Deciding which combination of protocols and methods to use depends on your viewing requirements, and on the properties of your network. The available options in AXIS Media Control are:

Unicast RTP	This unicast method (RTP over UDP) should be your first consideration for live unicast video, especially when it is important to always have an up-to-date video stream, even if some images are dropped.	Unicasting is used for video-on-demand broadcasting, so that there is no video traffic on the network until a client connects and requests the stream. Note that there are a maximum of 20 simultaneous unicast connections.
RTP over RTSP	This unicast method (RTP tunneled over RTSP) is useful as it is relatively simple to configure firewalls to allow RTSP traffic.	
RTP over RTSP over HTTP	This unicast method can be used to traverse firewalls. Firewalls are commonly configured to allow the HTTP protocol, thus allowing RTP to be tunneled.	
Multicast RTP	<p>This method (RTP over UDP) should be used for live multicast video. The video stream is always up-to-date, even if some images are dropped.</p> <p>Multicasting provides the most efficient usage of bandwidth when there are large numbers of clients viewing simultaneously. A multicast broadcast cannot however, pass a network router unless the router is configured to allow this. It is not possible to multicast over the Internet, for example.</p> <p>Note also that all multicast viewers count as one unicast viewer in the maximum total of 20 simultaneous connections.</p>	

AXIS Media Control negotiates with the video encoder to determine the transport protocol to use in the order listed above. This order can be changed and the options disabled to suit specific requirements.

Important!

H.264 is licensed technology. The video encoder includes one viewing client license. Installing additional unlicensed copies of the viewing client is prohibited. To purchase additional licenses, contact your Axis reseller.

Motion JPEG

This format uses standard JPEG still images for the video stream. These images are then displayed and updated at a rate sufficient to create a stream that shows constantly updated motion.

The Motion JPEG stream uses considerable amounts of bandwidth, but provides excellent image quality and access to every image contained in the stream. The recommended method of accessing Motion JPEG live video from the video encoder is to use the AXIS Media Control in Internet Explorer in Windows.

AXIS Media Control (AMC)

The recommended method of accessing live video from the video encoder is to use the AXIS Media Control in Internet Explorer in Windows.

The AMC Control Panel can be used to configure various video settings. Please see the AXIS Media Control User's Manual for more information.

The AMC Control Panel is automatically installed on first use, after which it can be configured.

Open the AMC Control Panel from:

- Windows Control Panel (from the Start menu)
- Alternatively, right-click the video image in Internet Explorer and select Settings.

Alternative methods of accessing the video stream

Video/images from the video encoder can also be accessed in the following ways:

- Motion JPEG server push (if supported by the client, Firefox, for example). This option maintains an open HTTP connection to the browser and sends data as and when required, for as long as required.
- Still JPEG images in a browser. Enter the path `http://<ip>/axis-cgi/jpg/image.cgi`
- Windows Media Player. This requires AXIS Media Control and the H.264 viewing client to be installed. The paths that can be used are listed below in the order of preference:
 - Unicast via RTP: `axrtpu://<ip>/axis-media/media.amp`
 - Unicast via RTSP: `axrtsp://<ip>/axis-media/media.amp`
 - Unicast via RTSP, tunneled via HTTP: `axrtsphhttp://<ip>/axis-media/media.amp`
 - Multicast: `axrtpm://<ip>/axis-media/media.amp`
- To access the video stream from QuickTime™ the following paths can be used:
 - `rtsp://<ip>/axis-media/media.amp`
 - `rtsp://<ip>/axis-media/media.3gp`

Notes:

- The video encoder supports QuickTime 6.5.1 and later.
- QuickTime adds latency to the video stream (up to 3 seconds).
- It may be possible to use other players to view the H.264 stream using the paths above, although Axis does not guarantee this.
- <ip> = IP address

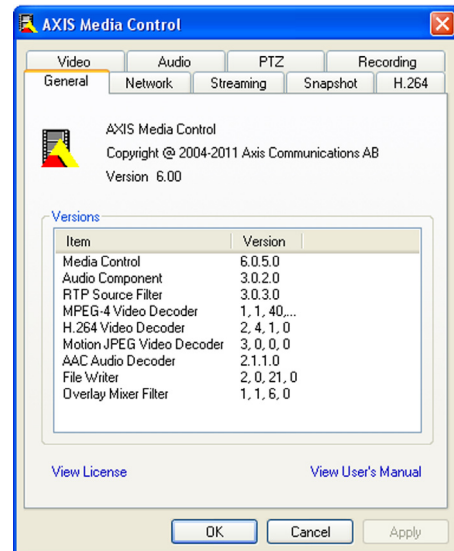

Video Settings

This section describes how to configure the video encoder, and is intended for product **Administrators**, who have unrestricted access to all the Setup tools; and **Operators**, who have access to the settings for Video, Live View Config, and Events.

You can configure the video encoder by clicking **Setup** in the top right-hand corner of the Live View page. Click  on this page to access the online help that explains the setup tools.

Video Stream

The video stream settings are separated into 3 tabs:

- Image
- H.264
- MJPEG

Image

Image Appearance

Use these settings to modify the image resolution and compression. Setting the compression level affects the image quality and the amount of bandwidth required, the lower the compression, the higher the image quality and the higher the bandwidth requirements. Enable **aspect ratio correction** to improve the image appearance when video from an analog camera is displayed on a digital screen (for example a computer monitor). The image can also be mirrored (reversed). See the online help files  for more information.

Video Stream

To avoid bandwidth problems on the network, the **frame rate** allowed to each viewer can be limited. Select the **Unlimited** radio button to allow the highest available frame rate or select the **Limited to...** radio button and enter a value (1-30) fps in the field.

Overlay Settings

Use these settings to include a text, date and time as overlay. Click  for information on available options.

Preview

For a preview of the image before saving, select a video format and click **Open...** When satisfied with the settings, click **Save**.

H.264

GOV Settings

The GOV structure describes the composition of the H.264 video stream which consists of 2 image forms, I-images and P-images. An I-image is a complete image, whereas a P-image is only the differences in the image as compared with the previous image. The GOV length determines how many P-images are sent before the next complete I-image is sent. Setting the GOV-length to a higher value saves considerably on bandwidth but if there is congestion on the network, there may be noticeable decay in the video quality. Setting the GOV-length to a lower value increases the video quality, in this case.

GOV length should not be higher than the set frame rate when using a pre-trigger buffer see *Pre-trigger and post-trigger buffers*, on page 17.

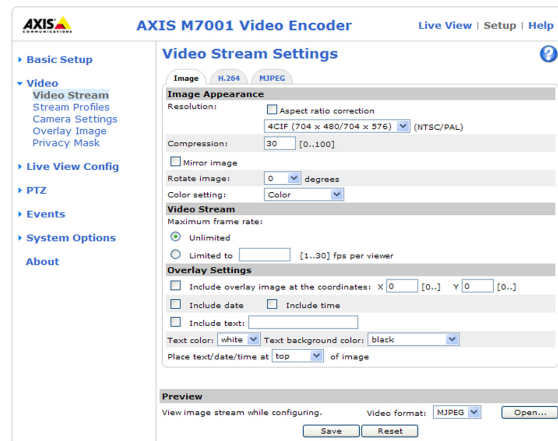

Text, date & time overlay

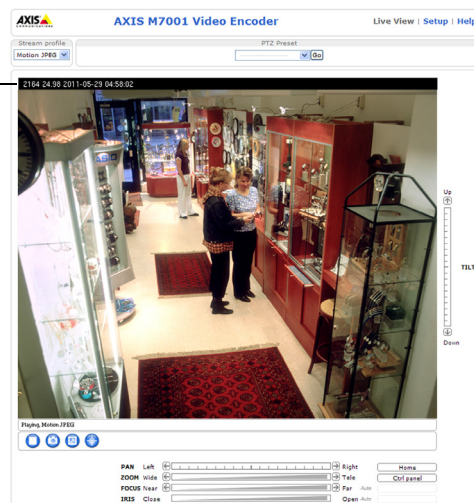

Bit Rate Control

The bit rate can be set as **Variable Bit Rate (VBR)** or **Constant Bit Rate (CBR)**. VBR adjusts the bit rate according to the image complexity, using up bandwidth for increased activity in the image, and less for lower activity in the monitored area.

CBR allows you to set a fixed **Target bit rate** that consumes a predictable amount of bandwidth. As the bit rate would usually need to increase for increased image activity, but in this case cannot, the frame rate and image quality are affected negatively. To partly compensate for this, it is possible to prioritize either the frame rate or the image quality whenever the bit rate needs to be increased. Not setting a priority means the frame rate and image quality are equally affected.

Note:

To determine a reasonable bit rate, go to **Setup > Video > Video Stream > Image**, check the **Include text** checkbox under **Overlay Settings** and enter the code **#b** in the field. The current bit rate will display as a text overlay on the Live View page.

To preview the image stream while configuring the GOV settings and Bit rate control, select **Open...** under **Preview**.

MJPEG

Sometimes the image size is large due to low light or complex scenery. Adjusting the **Maximum frame size** helps to control the bandwidth and storage used by the Motion JPEG video stream in these situations. Defining the frame size as **Unlimited** provides consistently good image quality at the expense of increased bandwidth and storage usage during low light. Limiting the frame size optimizes bandwidth and storage usage, but may give poor image quality. To prevent increased bandwidth and storage usage, the maximum frame size should be set to an optimal value.

Stream Profiles

There are 4 pre-programmed stream profiles available for quick set-up. Their settings can be adjusted and/or new customized profiles can be created. Each profile has a descriptive name, describing its usage and/or purpose. The profiles can be accessed from the Live View page.

Go to **Setup > Video > Stream Profiles** to set up and configure stream profiles.

- To create a new stream profile, click **Add** to bring up the Stream Profile Settings panel:
 1. Enter a unique name and a description for your profile.
 2. Select a **Video encoding** (H.264 or MJPEG) from the drop-down list.
 3. Modify the video stream settings under the **Image** and **H.264** or **MJPEG** tabs. See *Video Stream*, on page 11.
 4. Click **OK** to save the profile.
- To copy an existing stream profile, select the profile and click **Copy**. Enter a new profile name and modify the settings in the Stream Profile Settings panel.
- To modify an existing stream profile, select the profile and click **Modify** to open the Stream Profile Settings panel. Change the settings as above. For pre-programmed profiles, the original settings can always be restored by clicking the **Restore** button.
- To remove a stream profile, select the profile and click **Remove**. Pre-programmed profiles cannot be removed.

Camera Settings

This page provides access to the advanced image settings for the AXIS M7001.

Image Appearance

Color level – Select an appropriate level by entering a value in the range 0-100. Lower values mean less color saturation, while the value 100 gives maximum color saturation.

Brightness – The image brightness can be adjusted in the range 0-100, where a higher value produces a brighter image.

Contrast – Adjust the image's contrast by raising or lowering the value in this field.

Rotate image – The image can be rotated to the correct orientation. Select the appropriate value from the drop-down list.

Video Input

Physical connector – The AXIS M7001 has two physical video in connectors, BNC and Tele plug. When set to Auto, the video encoder automatically detects the physical connector that the camera is connected to. To change the video input manually, select the physical connector from the drop-down list.

Offset adjustments – If the image is surrounded by a black border, change these settings to remove the border. Be careful to only use low values, no more than 1-3, as higher values may put the image out of sync.

4CIF de-interlacing – The video signal from an analog camera can cause motion blur problems in the image due to interlacing. Check the box to apply a de-interlacing filter that improves image quality.

Once satisfied, click **Save**.

Note:

The error "503 service unavailable" occurs if another user is accessing a different Motion JPEG stream configuration, for example via the Live View page. Only one Motion JPEG configuration is available at a time.

Privacy Mask

A privacy mask is an area of solid color that prohibit users from viewing parts of the monitored area. Up to 3 privacy masks can be used. Privacy masks cannot be bypassed via the VAPIX® Application Programming Interface (API).

Privacy Mask List

The Privacy Mask List shows all the masks that are currently configured in the AXIS M7001 Video Encoder and if they are enabled.

Add/Edit Mask

To define a new mask:

1. Click **Add** and place the box over the desired area to conceal.
2. Choose a color, black, white, gray or red for the box from the drop-down list Privacy mask color
3. Enter a descriptive name in Mask name.
4. Click **Save**.

To edit a privacy mask, select it and reshape, move or change color as needed.

Live View Config

Layout

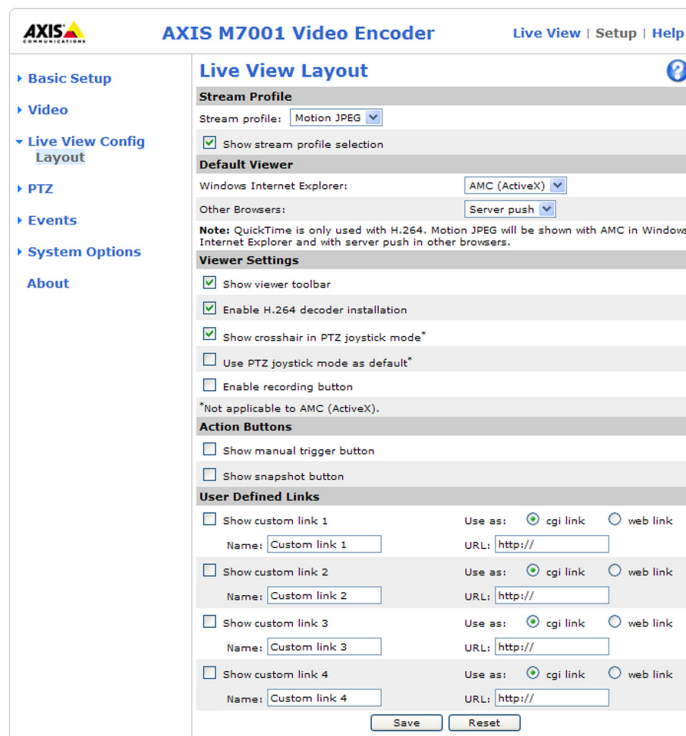

Stream Profile

From the **Stream Profile** drop-down list, select the stream profile that is to be used for the Live View page. Listed are the pre-programmed stream profiles as well as the ones created under **Setup > Video > Stream Profiles**. See *Stream Profiles*, on page 12, for more information.

Default Viewer

From the drop-down lists, select the default method for viewing video images for your browser. The video encoder attempts to show the video images in the selected video format and viewer. If this is not possible, the video encoder overrides the settings and selects the best available combination.

Browser	Viewer	Description
Windows Internet Explorer	AMC	Recommended viewer in Internet Explorer (H.264/Motion JPEG).
	QuickTime	H.264 only.
	Java applet	A slower imaging alternative to AMC. Requires one of the following installed on the client: <ul style="list-style-type: none"> JVM (J2SE) 1.4.2 or higher JRE (J2SE) 5.0 or higher
	Still image	Displays still images only. Click the Refresh button in your browser to view a new image.
Other browsers	Server Push	Recommended viewer for other browsers (Motion JPEG only).
	QuickTime	H.264 only.
	Java applet	A slower imaging alternative to Server Push (Motion JPEG only).
	Still image	Displays still images only. Click the Refresh button in your browser to view a new image.

Viewer Settings

Check the **Show viewer toolbar** box to display the AXIS Media Control (AMC) or the QuickTime viewer toolbar under the video image in your browser.

The administrator can disable the installation of the H.264 decoder included with AXIS Media Control. This is used to prevent installation of unlicensed copies. Additional decoder licenses can be purchased from your Axis dealer.

Enable **Show crosshair** in **PTZ joystick mode** and a cross will indicate the center of the image in PTZ joystick mode.

Check the **Use PTZ joystick mode as default** box to enable joystick mode. The mode can be changed temporarily using the PTZ Control Panel (see *PTZ Controls*, on page 25).

Check the **Enable recording** button to enable recording from the Live View page. The recordings are saved to the location specified in the AMC Control Panel (see *AXIS Media Control (AMC)*, on page 10).

Action Buttons

Check the boxes to display the action buttons on the Live View page.

The **manual trigger** button can be used to manually trigger and stop an event. See *Event Configuration*, on page 16.

The **snapshot** button can be used to save a snapshot from the video stream. This button is mainly intended for use with browsers other than Internet Explorer, or when not using AXIS Media Control to view the video stream. AXIS Media Control for Internet Explorer has its own snapshot button.

User Defined Links

User-defined links can link to web pages, or can be used to run scripts or activate and control external devices connected to the video encoder. Once configured, the links appear on the Live View page.

To set up a link, check the **Show custom link** box, select the **cgi link** or **web link** radio button, enter the URL and a descriptive name in the provided fields.

A link defined as a web link will open in a new window, while a cgi link will run for example a script in the background.

Example:

Set up cgi links to control a connected PTZ device from the Live View page. In this example, the links will start and stop a continuous pan and tilt movement.

1. Check Show Custom Link 1.
2. Enter a descriptive name, such as "Start continuous pan".
3. Select the Use as cgi link radio button and enter the cgi link in the field:
http://<ip>/axis-cgi/com/ptz.cgi?continuouspantiltmove=30,-30
4. Check Show Custom Link 2.
5. Enter a descriptive name, such as "Stop continuous pan".
6. Select the Use as cgi link radio button and enter the cgi link in the field:
http://<ip>/axis-cgi/com/ptz.cgi?continuouspantiltmove=0,0

For more information on the VAPIX® Application Programming Interface (API), see the Developer pages on Axis website <http://www.axis.com>

Note:

<ip> should be replaced by the IP address of the video encoder.

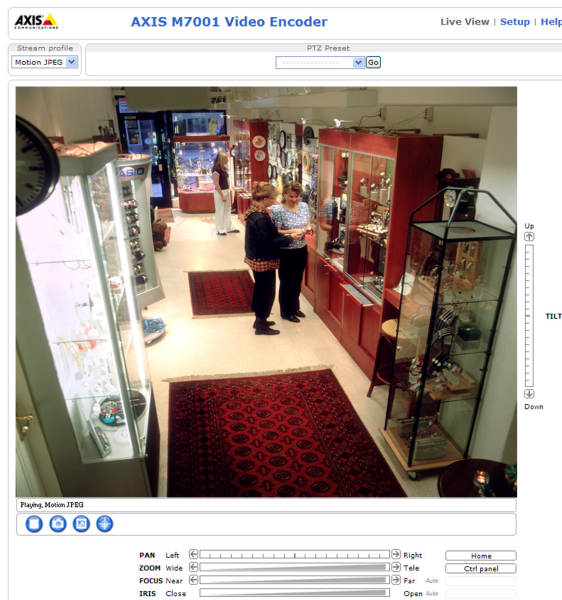

Axis communication AB — User-defined link

Event Configuration

An event or Event Type in the video encoder triggers actions when activated. An event type is a set of parameters that defines the actions. A common event type is an alarm that causes the video encoder to upload images. Many event types use an Event Server to receive uploaded images and notification messages.

This section describes how to configure the video encoder to perform certain actions when events occur.

Definitions

Event type	A set of parameters describing how and when the video encoder performs certain actions.
Triggered event – see page 17	An event that is started by some sort of signal, for example detected motion or a system event.
Scheduled event – see page 18	An event that runs during pre-programmed time period(s).
Action	This occurs when the event runs, for example, uploading of images to an FTP server, or email notification.

Event Servers

Event servers are used to receive uploaded image files and/or notification messages. To set up event server connections in your video encoder, go to Setup > Events > Event Servers and enter the required information for the server type.

Server type	Purpose	Information required
FTP Server	<ul style="list-style-type: none"> Receives uploaded images 	<ul style="list-style-type: none"> Descriptive name Network address and Upload path User name and password Port number
HTTP Server	<ul style="list-style-type: none"> Receives notification messages Receives uploaded images 	<ul style="list-style-type: none"> Descriptive name URL (network address and script) User name and password Proxy address, proxy port, proxy user name and password
TCP Server	<ul style="list-style-type: none"> Receives notification messages 	<ul style="list-style-type: none"> Descriptive name Network address (IP address or host name) Port number

For details on each setting, see the online help  available from each web page.

When the setup is complete, the connection can be tested by clicking the Test button (the connection test takes approximately 10 seconds).

Event Types

An Event Type describes how and when the video encoder performs certain actions.

Example: If somebody passes in front of the camera connected to the video encoder and an event has been configured to detect and respond to motion, the video encoder can record and save images to an FTP server and send a notification email to an email address. Images can be sent as email attachments.

Triggered event

A triggered event can be activated by:

- A manual trigger – using the manual trigger button on the Live View page or through the VAPIX® Application Programming Interface (API).
- Video loss.
- Movement in a motion detection window.
- Restart, for example after power loss.
- Pan Tilt Zoom preset positions. This option is only available when a PTZ device is used with the video encoder. See *Pan Tilt Zoom*, on page 21.

How to set up a triggered event

The following example describes how to set up the video encoder to upload images when movement is detected in a configured motion detection window.

1. Click **Add triggered...** on the **Event Types** page. The **Triggered Event Type Setup** page is opened.
2. Enter a descriptive **Name** for the event, such as **Detected motion**.
3. Set the **Priority** – High, Normal or Low (see the online help for details).
4. Set the **Respond to Trigger...** parameters to define when the event is active, for example, after office hours.
5. Select the motion detection alternative from the **Triggered by...** drop-down list. Select a motion detection window and specify if the event should be triggered when motion starts or stops.

Note:

A motion detection must first be configured, see *Set up a motion detection include window*, on page 19.

6. Set the **When Triggered...** parameters, that is, define what the video encoder will do if motion is detected. To upload images, select **Save stream** and enter the required information. See *Save stream*, below, and the online help.
7. Click **OK** to save the event in the Event Types list.

Please see the online help  for detailed descriptions of each available option.

Note:

Up to 10 event types can be configured in the video encoder, and up to four of these can be configured to upload images. File names can be formatted according to specific requirements. See *File Naming & Date/Time Formats* in the online help.

Save stream

To upload images to an FTP or HTTP server, or to send images by email, check the **Save stream** box.

Image frequency – Set the image frequency to a desired frame rate. The frame rate will be the best possible, but might not be as high as specified, especially if uploading via a slow connection.

Pre-trigger and post-trigger buffers

Pre- and post-trigger buffers are very useful when checking to see what happened immediately before and/or after a trigger, for example, 30 seconds before and/or after motion was detected. All uploaded images are JPEG images.

Include pre-trigger buffer – contains images from the time immediately preceding the trigger. Check the box to enable the pre-trigger buffer and specify the desired buffer length in seconds, minutes or hours.

Include post-trigger buffer – Contains images from the time immediately after the trigger. The post-trigger buffer is configured in the same way as the pre-trigger buffer.

Notes:

- Pre-trigger and post-trigger buffers will be lost if the connection to the event server fails.
- The maximum length of the pre-/post-trigger buffer depends on the video image size and selected frame rate.
- If the pre- or post-trigger buffer is too large for the video encoder's internal memory, the frame rate is reduced and individual images may be missing. If this occurs, an entry is created in the unit's log file.

Continue image upload (unbuffered) – Upload video images for a specified length of time or for as long as the trigger is active.

Select type – Upload images to an FTP or HTTP server, or send images by email.

Create folder – Images uploaded to FTP and HTTP servers can be saved to designated folders. Folders can for example be named using the current date and time, see *File Naming & Date/Time Formats* in the online help .

Base file name – Used to name all uploaded images. Add a suffix or use your own file format to give the images unique names, see *File Naming & Date/Time Formats* in the online help .

Use stream profile – Use the settings saved in a stream profile when uploading or emailing images. Only MJPEG profiles can be selected.

Scheduled event

A **Scheduled event** is activated at preset times in a repeating pattern on selected weekdays.

How to set up a scheduled event

The following example describes how to configure the video encoder to save images from pre-programmed time periods.

1. Click **Add scheduled...** on the **Event Types** page.
2. Enter a descriptive **Name** for the event, such as *Scheduled email*.
3. Set the **Priority** (High, Normal or Low).
4. Set the **Activation Time** parameters (24h clock) for the event. For example, select *Recurrence pattern* and let the event start on *Fridays at 18.00* with a duration of *62 hours*.
5. Set the **When Activated...** parameters, that is, define what the video encoder will do when the event is active. To save images, select **Save stream** and enter the required information. See *Save stream*, on page 17.
6. Click **OK** to save the event in the **Event Types** list.

Please see the online help  for detailed descriptions of each available option.



Motion Detection

Motion detection is used to generate an alarm whenever movement occurs (or stops) in the video image. A total of 10 Include and/or Exclude windows can be configured.

- **Include** windows target specific areas within the video image.
- **Exclude** windows define areas within an Include window that should be ignored (areas outside Include windows are automatically ignored).

Once configured, the motion detection windows appear in the list of available triggers for triggered events. See *How to set up a triggered event*, on page 17.

Note:

Using the motion detection feature may decrease the video encoder's overall performance.

Set up a motion detection include window

1. Go to **Setup > Events > Motion Detection**.
2. Create a new motion detection window:
 - a) Using AXIS Media Control (Internet Explorer): Select the radio button **Configure Included Windows** and click **New**. Select the new window in the list of windows and enter a descriptive name.
 - b) Using the Java applet: Click **Add Window**. Select the **Include** radio button and enter a descriptive name in the field below.
3. Adjust the size (drag the bottom right-hand corner) and position (click on the text at the top and drag to the desired position) of the active window.
4. Adjust the **Object Size**, **History** and **Sensitivity** profile sliders (see table below for details). Any detected motion within an active window is indicated by red peaks in the **Activity** window (the active window has a red frame).
5. Click **Save**.

To exclude parts of the Include window, create an Exclude window by selecting the **Exclude** option and position the Exclude window within the Include window.

To delete an include/exclude window:

- a) Using AXIS Media Control (Internet Explorer): Select the window in the list of windows and click **Del**.
- b) Using the Java applet: Select the window and click on the cross in the upper right corner.

Please see the online help  for descriptions of each available option.

	Object Size	History	Sensitivity
High level	Only very large objects trigger motion detection	An object that appears in the region will trigger the motion detection for a long period	Ordinary colored objects on ordinary backgrounds will trigger the motion detection
Low level	Even very small objects trigger motion detection	An object that appears in the region will trigger motion detection for only a very short period	Only very bright objects on a dark background trigger motion detection
Default value	Low	High	High

Examples:

- Use a high **object size** level to avoid triggering on small objects in the video image.
- Select a high **history** level to reduce the number of triggers in situations with a lot of movement during a short period of time.
- Select a low **sensitivity** level to detect flashing light only. In other cases a high sensitivity level is recommended.

Note:

The error "503 service unavailable" occurs if another user is accessing a different Motion JPEG stream configuration, for example via the Live View page. Only one Motion JPEG configuration is available at a time.

Pan Tilt Zoom

Installing PTZ devices

This Axis product supports several PTZ devices. Please see www.axis.com for a complete list of supported devices, and to obtain the correct driver. Follow the instructions below to install a PTZ device.

Installing a PTZ device is accomplished in two steps:

- Installing the PTZ driver
- Setting up the COM Port, see page 32.

Installing the PTZ driver

1. Go to PTZ > Driver Selection.



2. Under Upload, click **Browse...** to find the driver. The driver has the file extension.ptz (e.g. driver.ptz).
3. Click **Upload**. If the driver was successfully uploaded, it will be available under **Driver Management > Uploaded drivers**.
4. From the **Uploaded drivers** drop-down list, select the driver to install and click **Save**.
5. Enter the **Device ID**, select the **Device Type** from the drop down list and click **Save**.
6. Set up the COM Port for the PTZ driver. See *COM Port*, on page 32 for instructions.

Notes:

- After a PTZ driver has been installed, **PTZ > Advanced > Device** will contain additional driver specific settings that can be configured for the PTZ device.
- Advanced users and application developers can also use the Axis Application Programming Interface and HTTP specification for generic control of PTZ devices using CGI commands or a TCP/IP client. Refer to the Axis website at www.axis.com for further information.

Uninstalling a PTZ driver

1. Go to **PTZ > Driver Selection**
2. Click **Uninstall**

PTZ Configuration

Once a PTZ driver has been installed, additional sub menus will appear in the menu to the left under PTZ.

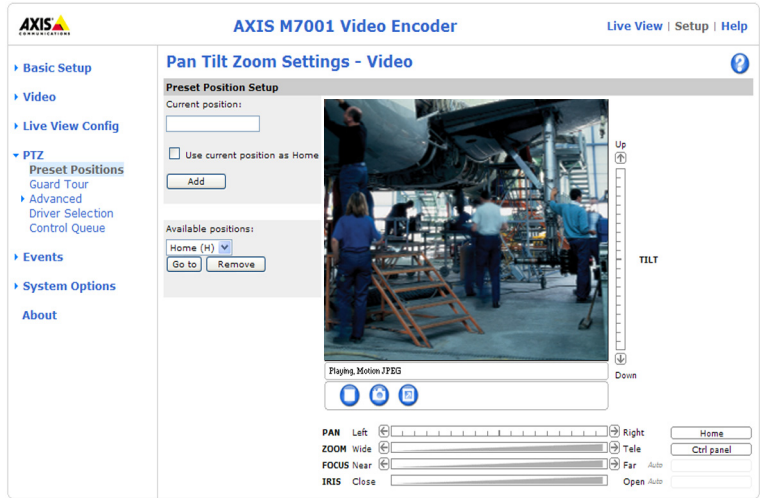

Preset Positions

A preset position is a pre-defined camera view that can be used to quickly steer the camera to a specific location.

From **Preset Position Setup**, use the PTZ controls to steer the camera to the desired position. When satisfied with the camera position, enter a descriptive name and click **Add**. The camera's position, iris and focus settings are saved as a preset position.

On the **Live View** page, the camera view can be moved to a preset position at any time by selecting the preset's name from the **Source** drop-down list. Preset positions are also used in **guard tours** and as actions to triggered and scheduled **events**.

One preset can be set as the **Home** position, which is readily accessible by clicking the **Home** button on the **Live View** page and in the **Preset Position Setup**. To set the **Home** position, steer the camera to the desired position and check the **Use current position as Home** box. The position's name will have (H) added to the end, for example, **Office Entrance (H)**.

Note:

The error "503 service unavailable" occurs if another user is accessing a different Motion JPEG stream configuration, for example via the **Live View** page. Only one Motion JPEG configuration is available at a time.

Guard Tour

A guard tour moves between chosen **preset positions**, one-by-one, in a pre-determined order or at random, and for configurable time periods. The guard tour sequence will keep running after the user has logged off or closed the browser.



Advanced

Device Settings

The device settings window is for driver-specific settings, so the appearance of this window can vary depending on the driver installed. Options that can be configured include: **Driver Specific Settings for Video Source 1**, **Mechanical Limits for Moving Video Source 1**, **Light Control for Video Source 1** and **Extended Driver Specific Settings for Video Source 1**.

Note:

For download and installation information about PTZ drivers for your Axis product please visit www.axis.com

Controls

Driver-specific **Panel Shortcut Command Buttons** can be created to provide direct access to auxiliary commands provided by the PTZ driver. The buttons will be displayed in the PTZ control panel which is opened by clicking **Ctrl Panel** on the Live View page.

The pan, tilt, zoom, focus and iris controls can be disabled by unchecking the boxes under **Enable/Disable controls**.

See also *PTZ Controls*, on page 25, and *Control panel*, on page 26.

Limits

Define the pan, tilt, zoom and focus limits. Movements to the left and right, up and down can be restricted to narrow the area under surveillance. The near focus limit can be set to avoid focusing on objects too close to the camera.

Note:

To be able to set limits, the driver needs to be an "absolute" driver.

OSD Menu

If the PTZ unit supports an internal configuration menu, the menu can be accessed using the On-Screen Display (OSD). Configure the analog camera by opening and navigating through its internal menu in this page.

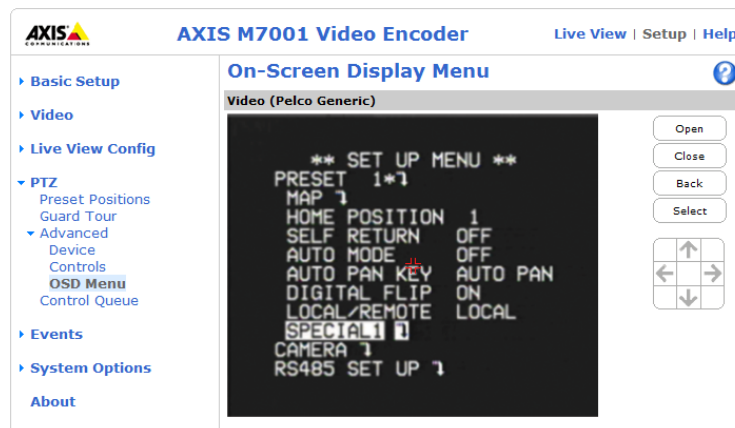

Note:

The error "503 service unavailable" occurs if another user is accessing a different Motion JPEG stream configuration, for example via the Live View page. Only one Motion JPEG configuration is available at a time.

Control Queue

The PTZ control queue gives one user exclusive access to the PTZ controls for a limited amount of time, placing other users in queue. To keep their place in the queue, waiting clients must regularly poll the video encoder. The polltime and the maximum number of users allowed in the queue can be configured on this page.

A user who belongs to a group (see *Security*, on page 27) with a higher PTZ priority can go before other users in the queue and take control of the video encoder. The order of priority for taking control of the queue is:

1. **Administrators** – An administrator takes over PTZ control regardless of who is first in queue. The administrator will be removed from the queue 60 seconds after their last PTZ control command.
2. **Event** – The video encoder can be configured to go to a preset position when triggered by an alarm (see *Event Configuration*, on page 16). The event will immediately be placed first in the queue, except when an administrator is in control.
3. **Operator** – Same as administrator, but with lower priority.
4. **Guard Tour** – A guard tour has PTZ control for an indefinite period of time. It may be overridden by an operator, event or administrator. The guard tour will resume when higher priority groups leave the queue. For more information see *Guard Tour*, on page 22.
5. **Viewer** – Multiple viewers must wait for their turn. The viewer has 60 seconds PTZ control before control is passed to the next viewer in queue.

Notes:

- To identify the different users in the user group, the web browser must be set to enable cookies.
- The administrator can enable/disable PTZ control for selected users.

PTZ Controls

If the video encoder has been appropriately configured, the Live View page displays the controls available for the installed Pan Tilt Zoom (PTZ) device. The administrator can enable/disable the controls for specified users under **System Options > Security > Users > User List**.



The controls shown depends on the PTZ device. The most common controls are:

- the Pan bar – moves the camera to the right and left
- the Tilt bar – tips the camera up and down
- the Zoom bar – zooms the view in and out. Note that this is only available if the camera is fitted with a zoom lens
- the Iris bar – adjusts the brightness of the image

Clicking on the bars themselves or on the arrows at the end of the bars moves the camera to a new position. The type of movement and the location of this new position depends on the type of PTZ driver.

When controlling the camera using a **relative** PTZ driver the new position is relative (see right) to the previous position, for example, left of, below, or above. Clicking the bar further from the center results in a larger movement.



In contrast, when using an **absolute** driver, each position on the bar (see the bars in the illustration above) represents a defined position in the device's range of movement, with the center of the bar representing the point midway between the two extremes of movement.

Clicking a position directly on the bar moves the camera directly to the new position in one smooth movement. Clicking on the arrows at the ends of a bar causes an incremental change.

Using CGI links to control PTZ devices

User-defined CGI links on the Live View page can be used to issue API (Application Programming Interface) requests, such as PTZ commands. These links are configured in the Live View Layout settings, see *User Defined Links*, on page 15.

PTZ control modes

The PTZ device can also be controlled using **click-in-image** movement, which has two different types of navigation - **Center** and **Joystick**.



Click the **Center mode** button and click on a position in the image to center the camera view on that position.



Click the **Emulate joystick mode** button and click in the image to move the camera in the direction of the mouse pointer.

Note:

There is also joystick support in AXIS Media Control (AMC).

Control panel

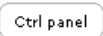

Click the **Ctrl panel** button to access the PTZ control panel. The buttons available in the control panel depend on the installed PTZ driver.

- **Auto focus** – automatically adjust the image focus
- **Auto iris** – automatically adjust the amount of light reaching the image sensor
- **Backlight comp** – enabling backlight compensation makes the subject clearer if the image background is too bright, or if the subject is too dark.
- **IR cut filter** – when set to off, the camera will be able to “see” infrared (IR) light, for example at night; it increases light sensitivity. The image is shown in black & white when the IR cut filter is off. Set to Auto to automatically turn the filter off when the available amount of visible light falls below the minimum requirement.
- **Driver-specific shortcut command buttons** can also appear in the control panel, see *Advanced*, on page 23.

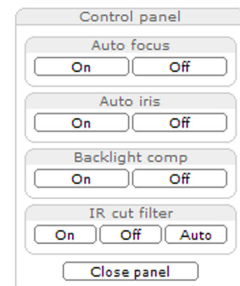

PTZ Control Queue

With the PTZ control queue enabled the time each user is in control of the PTZ settings is limited. Click the buttons to request or release control of the PTZ controls. For more information see *Control Queue*, on page 24.



System Options

Security

Users

User access control is enabled by default. An administrator can set up other users, by giving these user names and passwords. It is also possible to allow anonymous viewer login, which means that anybody may access the Live View page, as described below:

The user list displays the authorized users and user groups (levels):

Viewer	Provides the lowest level of access, which only allows access to the Live View page.
Operator	An operator can view the Live View page, create and modify events, and adjust certain other settings. Operators have no access to System Options.
Administrator	An administrator has unrestricted access to the Setup tools and can determine the registration of all other users.

HTTP/RTSP Password Settings – Select the type of password to allow. You may need to allow unencrypted passwords if there are viewing clients that do not support encryption, or if you recently upgraded the firmware and the existing clients do support encryption, but need to log in again, and be configured to use this functionality.

User Settings – Check the relevant box to enable **anonymous viewer login**; this allows any viewer direct access to the Live View page.

Enable Basic Setup – Before using the AXIS M7001, there are certain settings that should be made, most of which require administrator access privileges. To quickly access these settings use the Basic Setup in the menu. All settings are also available from the standard setup links in the menu. Basic Setup is enabled by default but can be disabled and removed from the menu.

IP Address Filter

Enable IP Address Filtering to allow or deny access to the video encoder. Once enabled, the IP addresses in the list are allowed or denied access according to the choice made in the drop-down list **Allow/Deny the following IP addresses**.

The administrator can add up to 256 IP address entries to the list (a single entry can contain multiple IP addresses). The users from these IP addresses need to be specified in the user list with the appropriate access rights. This is done from **Setup > System Options > Security > Users**.

HTTPS

The video encoder supports encrypted browsing using HTTPS.

A self-signed certificate can be used until a Certificate Authority-issued certificate has been obtained. Click the **Create self-signed certificate** button to install a self-signed certificate. Although self-signed certificates are free and offer some protection, true security is only implemented after the installation of a signed certificate issued by a Certificate Authority.

A signed certificate can be obtained from an issuing Certificate Authority by clicking the **Create Certificate Request** button. When the signed certificate is returned, click the **Install signed certificate** button to import the certificate. The properties of any certificate request currently resident in the video encoder or installed can also be viewed by clicking the **Properties** button. The **HTTPS Connection Policy** must also be set in the drop-down lists to enable HTTPS in the video encoder.

For more information, please refer to the online help .

Date & Time

Current Server Time – Displays the current date and time (24h clock). The time can be displayed in 12h clock format in the overlay (see below).

New Server Time – Select your time zone from the drop-down list. If you want the server clock to automatically adjust for daylight savings time, select the **Automatically adjust for daylight saving time changes**.

From the **Time mode** section, select the preferred method to use for setting the time:

- **Synchronize with computer time** – Sets the time from the clock on your computer.
- **Synchronize with NTP Server** – The video encoder will obtain the time from an NTP server every 60 minutes.
- **Set manually** – This option allows you to manually set the time and date.

Note:

If using a host name for the NTP server, a DNS server must be configured under **TCP/IP** settings. See *Basic TCP/IP Settings*, below.

Date & Time Format Used in Images – Specify the formats for the date and time (12h or 24h) displayed in the video streams. In addition to the predefined formats, customized date and time formats can also be used. See **File Naming & Date/Time Formats** in the online help  for information on how to create your own date and time formats.

Network

Basic TCP/IP Settings

AXIS M7001 supports both IP version 4 and IP version 6. Both versions may be enabled simultaneously, and at least one version must always be enabled. When using IPv4, the IP address for the video encoder can be set automatically via DHCP, or a static IP address can be set manually. If IPv6 is enabled, the video encoder receives an IP address according to the configuration in the network router. There is also the option of using the AXIS Internet Dynamic DNS Service. For more information on setting the IP address, please see the Installation Guide supplied with the product.

Network Settings

Click the View button for an overview of the IP configuration of the video encoder.

IPv4 Address Configuration

Check the box to enable IPv4.

Obtain IP address via DHCP – Dynamic Host Configuration Protocol (DHCP) is a protocol that lets network administrators centrally manage and automate the assignment of IP addresses on a network. DHCP is enabled by default. Although a DHCP server is mostly used to set an IP address dynamically, it is also possible to use it to set a static, known IP address for a particular MAC address.

Note:

DHCP should only be enabled if using dynamic IP address notification (see below), or if your DHCP server can update a DNS server, which then allows you to access the AXIS M7001 by name (host name). If DHCP is enabled and you cannot access the unit, you may have to reset it to the factory default settings and then perform the installation again.

Use the following IP address – To use a static IP address for the AXIS M7001, check the radio button and then make the following settings:

- **IP address** – Specify a unique IP address for your AXIS M7001. (To check if the IP address you intend to use is available or not, click the Test button)
- **Subnet mask** – Specify the mask for the subnet the AXIS M7001 is located on
- **Default router** – Specify the IP address of the default router (gateway) used for connecting devices attached to different networks and network segments.

IPv6 Address Configuration

Check the box to enable IPv6. Other settings for IPv6 are configured in the network router.

Services

Enable ARP/Ping setting of IP address – The IP address can be set using the ARP/Ping method (for instructions, see the Installation Guide supplied with the product), which associates the unit's MAC address with an IP address. Check this box to enable the service. Leave disabled to prevent unintentional resetting of the IP address.

Notes:

- The ARP/Ping service is automatically disabled two minutes after the unit is started, or as soon as an IP address is set.
- Pinging the unit is still possible when this service is disabled.

Enable AVHS – AXIS Video Hosting System (AVHS) in conjunction with an AVHS service provides easy and secure Internet access to live and recorded video accessible from any location. For more information and help to find a local AVHS Service Provider please go to www.axis.com. If AVHS is not to be used this option can be disabled.

- **One-click enabled** – Press the camera's control button (see *Hardware Overview*, on page 5) until the status LED blinks green to install the camera using an AVHS service. Once registered the camera stays connected to the AVHS service. If the camera is not registered within 24 hours after the button is pressed, the camera will disconnect from the AVHS service.
- **Always** – The camera will constantly attempt to connect to the AVHS service over the Internet. Once registered the camera will stay connected to the service. This option can be used when the camera is already installed and it is not convenient to use the one-click installation.

AXIS Internet Dynamic DNS Service – Use the AXIS Internet Dynamic DNS Service to assign a host name for easy access to your video encoder. Click **Settings...** to register the video encoder with the AXIS Internet Dynamic DNS Service, or to modify the existing settings (requires access to the Internet). The domain name currently registered at the AXIS Internet Dynamic DNS Service for your product can at any time be removed.

The Control button (see page 5) can be used to register, or update, the video encoder with the AXIS Internet Dynamic DNS Service:

1. Connect the product to the local network. Wait for the Status LED indicator to show a steady green.
2. Press the Control button once. The Status LED indicator will flash green while the product connects to the AXIS Internet Dynamic DNS Service.
3. Wait for the Status indicator to show a steady green. If the Status indicator flashes red for 10 seconds, the product cannot access the DNS Service and the IP address must be set using an alternative method (see the product's Installation Guide).
4. Visit www.axiscam.net to complete the process. This must be done within 60 minutes of pressing the button.

For more information, please refer to the online help  and www.axiscam.net

Advanced TCP/IP Settings

DNS Configuration

DNS (Domain Name Service) provides the translation of host names to IP addresses on your network.

Obtain DNS server address via DHCP – Automatically use the DNS server settings provided by the DHCP server. Click the **View** button to see the current settings.

Use the following DNS server address – Enter the desired DNS server by specifying the following:

- Domain name – Enter the domain(s) to search for the host name used by the video encoder. Multiple domains can be separated by semicolons (;). The host name is always the first part of a Fully Qualified Domain Name, for example, myserver is the host name in the Fully Qualified Domain Name myserver.mycompany.com where mycompany.com is the Domain name.
- DNS servers – Enter the IP addresses of the primary, and secondary DNS servers.
Note: This is not mandatory with regard to secondary DNS servers.

NTP Configuration

Obtain NTP server address via DHCP – Check this radio button to automatically look up and use the NTP server settings as provided by DHCP. Click the **View** button to see the current settings.

Use the following NTP server address – To use manual settings, check this radio button and enter the host name or IP address of the NTP server.

Host Name Configuration

The video encoder can be accessed using a host name, instead of an IP address. The host name is usually the same as the assigned DNS Name.

For more information, please see *Security*, on page 27 and the online help [?](#).

Link-Local IPv4 Address

This is enabled by default and assigns the video encoder an additional IP address for use with UPnP™. The video encoder can have both a Link-Local IP and a static/DHCP-supplied IP address at the same time – these will not affect each other.

HTTP and HTTPS

The default HTTP/HTTPS port numbers (80 and 443 respectively) can be changed to any port within the range 1024-65535. This is useful for simple security port mapping, for example.

NAT traversal (port mapping) for IPv4

A broadband router allows devices on a private network (LAN) to share a single connection to the Internet. This is done by forwarding network traffic from the private network to the "outside", that is, the Internet. Security on the private network (LAN) is increased since most broadband routers are pre-configured to stop attempts to access the private network (LAN) from the public network/Internet.

Use **NAT traversal** when your video encoder is located on an intranet (LAN) and you wish to make it available from the other (WAN) side of a NAT router. With NAT traversal properly configured, all HTTP traffic to an external HTTP port in the NAT router is forwarded to the video encoder.

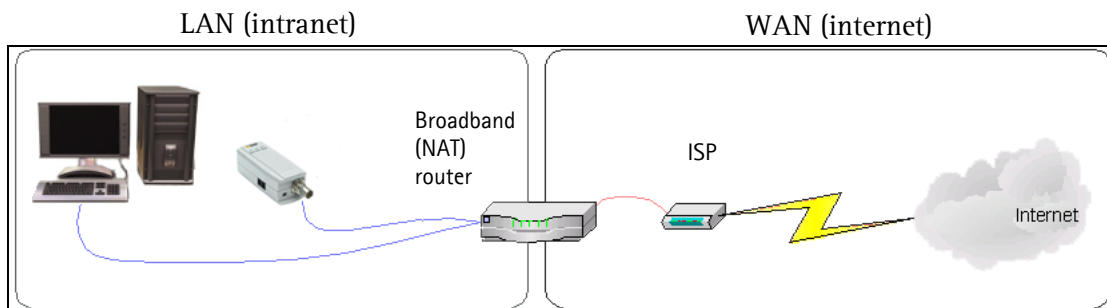

Notes:

- For NAT traversal to work, this must be supported by the broadband router. The router must also support UPnP™.
- The broadband router has many different names: "NAT router", "Network router", Internet Gateway", "Broadband sharing device" or "Home firewall" but the essential purpose of the device is the same.

Enable/Disable – When enabled, the video encoder attempts to configure port mapping in a NAT router on your network, using UPnP™. Note that UPnP™ must be enabled in the video encoder (see **System Options > Network > UPnP**).

Use manually selected NAT router – Select this option to manually select a NAT router and enter the IP address for the router in the field provided.

If a router is not manually specified, the video encoder automatically searches for NAT routers on the network. If more than one router is found, the default router is selected.

Alternative HTTP port – Select this option to manually define an external HTTP port. Enter the port number in the field provided. If no port is entered here a port number is automatically selected when NAT traversal is enabled.

Notes:

- An alternative HTTP port can be used/be active even if NAT traversal is disabled. This is useful if your NAT router does not support UPnP™ and you need to manually configure port forwarding in the NAT router.
- If you attempt to manually enter a port that is already in use, another available port is automatically selected.
- When the port is selected automatically it is displayed in this field. To change this enter a new port number and click Save.

FTP

The FTP server running in the video encoder enables the upload of new firmware and user applications. Check the box to enable the service.

RTSP

The RTSP protocol allows a connecting client to start an H.264 stream. Check the box to enable the server and enter the RTSP port number to use. The default setting is 554. Note that H.264 video streams will not be available if this service is not enabled.

SOCKS

SOCKS is a networking proxy protocol. The video encoder can be configured to use a SOCKS server to reach networks on the other side of a firewall/proxy server. This functionality is useful if the video encoder is located on a local network behind a firewall, and notifications, uploads, alarms, and such need to be sent to a destination outside the local network (such as the Internet). See the online help  for more information.

QoS (Quality of Service)

Quality of Service (QoS) guarantees a certain level of a specified resource to selected traffic on a network. Quality can be defined as a maintained level of bandwidth, low latency and no packet losses. The main benefits of a QoS-aware network can be summarized as:

- The ability to prioritize traffic and thus allow critical flows to be served before flows with lesser priority.
- Greater reliability in the network, thanks to the control of the amount of bandwidth an application may use, and thus control over bandwidth races between applications.

The QoS in Axis network video products marks the data packets for various types of network traffic originating from the product. This makes it possible for network routers and switches to reserve a fixed amount of bandwidth for these types of traffic. The video encoder marks the following types of traffic:

- video
- event/alarm
- management network traffic

QoS Settings – For each type of network traffic supported by your Axis network video product, enter a DSCP (Differentiated Services Codepoint) value. This value is used to mark the traffic's IP header. When the marked traffic reaches a network router or switch, the DSCP value in the IP header tells the router or switch the type of treatment to apply to this type of traffic, for example, how much bandwidth to reserve for it. Note that DSCP values can be entered in decimal or hex form, but saved values are always shown in decimal.

For more information on Quality of Service, please see the Axis support web at www.axis.com/techsup

SMTP (email)

Enter the host names (or IP addresses) and port numbers for your primary and secondary mail servers in the fields provided, to enable the sending of notifications and image email messages from the video encoder to predefined addresses via SMTP.

If your mail server requires authentication, check the box for **Use authentication to log in to this server** and enter the necessary information. See the online help  for more information.

SNMP

The Simple Network Management Protocol (SNMP) allows remote management of network devices. Depending on the level of security required, select the version of SNMP to use. The three levels of security are:

- SNMP V1 – includes no security.
- SNMP V2c – uses very simple security. The community name can be specified as a password for read or read/write access to all supported SNMP objects. The community is the group of network devices using SNMP.
- SNMP V3 – provides encryption and secure passwords. HTTPS must be enabled.

UPnP™

The video encoder includes support for UPnP™. UPnP™ is enabled by default, and the video encoder then is automatically detected by operating systems and clients that support this protocol.

RTP/H.264

These settings are the RTP port range and the IP address, port number and Time-To-Live value used for multicasting. Only certain IP addresses and port numbers should be used for multicast streams. For more information, please see the online help .

Bonjour

The video encoder includes support for Bonjour. Bonjour is enabled by default, and the video encoder is automatically detected by operating systems and clients that support this protocol.

Ports & Devices

COM Port

This page contains settings for the RS-485/RS-422 serial interface. The RS-485 and RS-422 ports support several operational modes:

Generic TCP/IP – Allows the video encoder to receive data and send commands via TCP/IP.

Generic HTTP – Allows the video encoder to receive data and send commands via HTTP.

Pan Tilt Zoom – Used for control of a PTZ device. A PTZ device requires a driver. See *Installing PTZ devices*, on page 21 for more information. Drivers can be obtained from www.axis.com

See also *Unit connectors*, on page 35.

LED

The behavior of the Power, Network and Status LED indicators can be customized to meet specific requirements. To turn off the indicators select the Off (for the Power and Status LEDs) or Disabled (for the Network LED) option. The Status LED can also be set to flash at regular intervals. See also *LED indicators*, on page 5.

Maintenance

Restart – The video encoder is restarted without changing any setting.

Restore – The unit is restarted and most current settings are reset to factory default values. The settings that do not reset are:

- the boot protocol (DHCP or static)
- the static IP address
- the default router
- the subnet mask
- the product interface language

Default – The default button should be used with caution. Pressing this returns the video encoder's settings to the factory default values (including the IP address).

Upgrade Server – See *Upgrading the Firmware*, on page 37.

Support

Support Overview

The **Support Overview** page provides valuable information on troubleshooting and contact information, should you require technical assistance.

System Overview

System Overview is an overview of the video encoder's status and settings. Information that can be found here includes the video encoder's firmware version, IP address, security, event and image settings and recent log items. Many of the captions are also links to the proper **Setup** page to conveniently make adjustments in the video encoder's settings.

Logs & Reports

When contacting Axis support, please be sure to provide a valid Server Report with your query. The Access Log is automatically included in the server report.

Information

The **Server Report** and **Parameter List** may prove useful when troubleshooting a problem or when contacting the Axis support web.

- **System Log** – Provides information about system events.
- **Access Log** – By default, the Access Log lists all failed attempts to access the video encoder but can be configured to list all connections to the video encoder, whether successful or not. Go to **Support > Logs & Reports > Configuration** and select the desired level of information from the list. See below for more information. The Access Log is useful for various purposes such as tracking all access to the video encoder, simple web attraction tracking, system analysis and troubleshooting.
- **Server Report** – Provides information about the server status and should always be included when requesting support.
- **Parameter List** – Shows the unit's parameters and their current settings.
- **Connection List** – Lists all clients that are currently accessing video. It is also used for system analysis and troubleshooting.

Configuration

From the drop-down lists, select the size and level of information to be added to the **System Log** and **Access Log** files.

The default information level for the Access Log is set to Critical & Warnings, i.e. failed connections. However, in an error situation and when requesting support, set it to the highest information level Critical & Warnings & Info.

For the **Log Level for Email**, select from the drop-down list the level of information to send as email and enter the destination email address.

Advanced

Scripting

Scripting is an advanced function that enables you to customize and use scripts. This function is a very powerful tool.

Caution!

Improper use may cause unexpected behavior or even cause loss of contact with the unit. If a script does cause problems, reset the unit to its factory default settings.

Axis strongly recommends that you do not use this function unless you understand the consequences. Note that Axis support does not provide assistance for problems with customized scripts.

For more information, please visit the Developer pages at www.axis.com

File Upload

Files (e.g. web pages and images) can be uploaded to the AXIS M7001 and used as custom settings. Uploaded files are accessed through `http://<ip address>/local/<user>/<file name>` where <user> is the selected user access group (viewer, operator or administrator) for the uploaded file.

Plain Config

Plain Config is for the advanced user with experience of Axis video encoder configuration. All parameters can be set and modified from this page. Help is available from the standard help pages.

About

Here you can find basic information about your video encoder. You can also view third party software licenses.

Resetting to the Factory Default Settings

To reset the video encoder to the original factory default settings, go to the **System Options > Maintenance** web page (as described in *Maintenance*, on page 33) or use the **Control** button on the video encoder (see *Overview*, on page 5) as described below:

Using the Control Button

To reset the video encoder to the factory default settings using the Control button:

1. Disconnect the network cable.
2. Press and hold the Control button while reconnecting the network cable.
3. Keep the Control button pressed until the **Status Indicator** color changes to amber (this may take up to 15 seconds).
4. Release the Control button.
5. When the Status Indicator changes to green (which may take up to 1 minute), the process is complete and the video encoder has been reset. The unit now has the default IP address 192.168.0.90

Note:

For other methods of setting the IP address, please refer to the Installation Guide supplied with the product.

Unit connectors

Network and power – RJ-45 Ethernet connector supporting Power over Ethernet (PoE class 2). Using shielded cables is recommended.

Video in – For connecting an analog camera:

- BNC connector. Use a 75 Ohm coaxial video cable; recommended maximum cable length is 250 meters (800 feet).
Notes:
 - If the video source is to be connected in parallel with other equipment using a BNC T adaptor, disable the input termination by setting the 75 Ohm termination switch to OFF. Failure to do so may reduce image quality.
 - If the same video source is used as input to several video encoders, enable termination on all encoders.
- 2.5 mm tele plug connector.

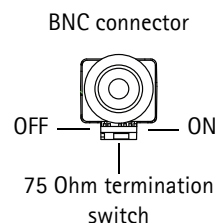

RS-422/RS-485 connector – Two 2-pin terminal blocks RS-485/422 serial interface for connecting auxiliary equipment, for example Pan Tilt Zoom devices.

The RS-485/422 serial port can be configured in the following port modes:

- Bidirectional RS-485 half-duplex port for data transmission using two wires, one combined RX/TX pair.
- Bidirectional RS-485 full-duplex port for data transmission using four wires, one RX pair and one TX pair.
- Unidirectional RS-422 port for transmitting or receiving data using two wires, RX- or TX pair.
- Bidirectional RS-422 full-duplex port for data transmission (point-to-point) using four wires, one RX pair and one TX pair.

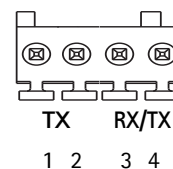

Function	Pin	Notes
RS 485/422TX(A)	1	TX pair for RS-422 and 4-wire RS-485
RS 485/422TX(B)	2	
RS-485A alt RS-485/422RX(A)	3	RX pair for all modes (combined RX/TX for 2-wire RS-485)
RS-485B alt RS-485/422RX(B)	4	

LED indicators

LED	Color	Indication
Network	Green	Steady for connection to a 100 Mbit/s network. Flashes for network activity.
	Amber	Steady for connection to 10 Mbit/s network. Flashes for network activity.
	Unlit	No network connection.
Status	Green	Steady green for normal operation.
	Amber	Steady during startup, during reset to factory default or when restoring settings.
	Red	Slow flash for failed upgrade.
Power	Green	Normal operation.
	Amber	Flashes green/amber during firmware upgrade.

The LED indicators can be disabled, see page 32.

Troubleshooting

Checking the Firmware

Firmware is software that determines the functionality of the video encoder. One of your first actions when troubleshooting a problem should be to check the current firmware version. The latest version may contain a correction that fixes your particular problem. The current firmware version in your encoder can be seen on the page **Setup > Basic Setup** or under **About**.

Upgrading the Firmware

When you upgrade your encoder with the latest firmware from Axis website, your encoder receives the latest functionality available. Always read the upgrade instructions and release notes available with each new release, before updating the firmware.

Note:

Preconfigured and customized settings are saved when the firmware is upgraded (provided the features are available in the new firmware) although this is not guaranteed by Axis Communications. Always read the instructions and release notes available with each new release, before upgrading the firmware.

1. Save the firmware file to your computer. The latest version of the firmware is available free of charge from Axis website at www.axis.com/techsup
2. Go to **Setup > System Options > Maintenance** in the encoder's web pages.
3. In the **Upgrade Server** section, browse to the desired firmware file on your computer. Click **Upgrade**.

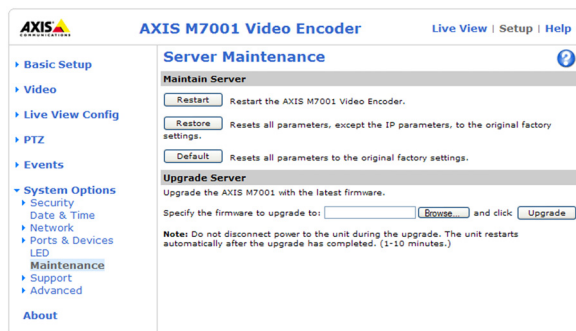

Notes:

- After starting the upgrade process, always wait at least 5-10 minutes before restarting the encoder, even if you suspect the upgrade has failed.
- Your dealer reserves the right to charge for any repair attributable to faulty upgrading by the user.
- The AXIS Camera Management software tool can be used for multiple upgrades. Please see Axis website at www.axis.com for more information.

Emergency Recovery Procedure

If power or network connection to the encoder is lost during the upgrade, the process fails and the unit becomes unresponsive. A flashing red Status LED indicates a failed upgrade. To recover the unit, follow the steps below. The serial number is found on the label attached to the bottom of the encoder.

1. **UNIX/Linux** - From the command line, type the following:

```
arp -s <IP address of encoder> <serial number> temp
ping -s 408 <IP address of encoder>
```

Windows - From a command/DOS prompt, type the following:

```
arp -s <IP address of encoder> <serial number>
ping -l 408 -t <IP address of encoder>
```

2. If the unit does not reply within a few seconds, restart it and wait for a reply. Press CTRL+C to stop Ping.
3. Open a browser and type in the encoder's IP address. In the page that appears, use the **Browse** button to select the upgrade file to use, for example, `axism7001.bin`. Then click the **Load** button to restart the upgrade process.
4. After the upgrade is complete (1-10 minutes), the unit automatically restarts and shows a steady green on the Power and Status LEDs and flashing green or amber on the Network LED.
5. Reinstall the encoder, see the Installation Guide.

If the emergency recovery procedure does not get the encoder up and running again, please contact Axis Support at www.axis.com/techsup/

Axis Support

If you contact Axis Support, please help us resolve your problem expediently by providing a Server Report and a detailed description of the problem.

The **Server Report** contains important information about the server and its software, as well as a list of the current parameters. The Access Logs is also included in the Server Report. Go to **Setup > System Options > Support > Support Overview** to generate a Server Report.

Symptoms, Possible Causes, and Remedial Action

Problems setting the IP address	
When using ARP/Ping	Try the installation again. The IP address must be set within two minutes after power has been applied to the encoder. Ensure the Ping length is set to 408. See the Installation Guide.
The encoder is located on a different subnet	If the IP address intended for the encoder and the IP address of your computer are located on different subnets, you will not be able to set the IP address. Contact your network administrator to obtain an appropriate IP address.
The IP address is being used by another device	Disconnect the encoder from the network. Run the Ping command. (In a Command/DOS window, type ping and the IP address of the unit). If you receive: Reply from <IP address>: bytes = 32; time = 10 ms..... - this means that the IP address may already be in use by another device on your network. You must obtain a new IP address and reinstall the unit. If you see: Request timed out - this means that the IP address is available for use with your encoder. In this case, check all cabling and reinstall the unit.
Possible IP address conflict with another device on the same subnet	The static IP address in the encoder is used before the DHCP server sets a dynamic address. This means that if the same default static IP address is also used by another device, there may be problems accessing the encoder. To avoid this, set the static IP address to 0.0.0.0.
The encoder cannot be accessed from a browser	
Cannot log in	When HTTPS is enabled, ensure that the correct protocol (HTTP or HTTPS) is used when attempting to log in. You may need to manually type http or https in the browser's address field.
The IP address has been changed by DHCP	If the encoder and client are on the same network, Run AXIS IP Utility to locate the encoder. Identify the encoder using its model or serial number. Alternatively: 1) Move the encoder to an isolated network or to one with no DHCP or BOOTP server. Set the IP address again, using the AXIS IP Utility (see the Installation Guide) or the ARP/Ping commands. 2) Access the unit and disable DHCP in the TCP/IP settings. Return the unit to the main network. The unit now has a fixed IP address that will not change.
Other networking problems	Test the network cable by connecting it to another network device, then Ping that device from your workstation. See instructions above.
The encoder is accessible locally, but not externally	
Broadband router configuration	To configure your broadband router to allow incoming data traffic to the encoder, enable the NAT-traversal feature which will attempt to automatically configure the router to allow access to the encoder. This is enabled from Setup > System Options > Network > TCP/IP Advanced. Note that the router must support UPnP™.
Firewall protection	Check the Internet firewall with your system administrator.
Default routers required	Check if you need to configure the default router settings.
Problems with the H.264 format	
No H.264 displayed in the client	Check that the relevant H.264 connection methods are enabled in the AMC Control Panel (network tab). In the AMC Control Panel, select the H.264 tab and click the button Set to default H.264 decoder.
No multicast H.264 displayed in the client	Check that the correct network interface is selected in the AMC Control Panel (network tab). Check with your network administrator that the multicast addresses used by the encoder are valid for your network. Check with your network administrator to see if there is a firewall preventing viewing.
Multicast H.264 only accessible by local clients	Check if your router supports multicasting, or if the router settings between the client and the server need to be configured. The TTL (Time To Live) value may need to be increased.
Poor rendering of H.264 images	Color depth set incorrectly on clients. Set to 16-bit or 32-bit color. If text overlays are blurred, or if there are other rendering problems, you may need to enable Advanced Video Rendering from the H.264 tab in the AMC Control Panel. Ensure that your graphics card is using the latest device driver. The latest drivers can usually be downloaded from the manufacturer's website.
Color saturation is different in H.264 and Motion JPEG	Modify the settings for your graphics adapter. Please see the adapter's documentation for more information.

Lower frame rate than expected	Reduce number of applications running on the client computer. Limit the number of simultaneous viewers. Check with the system administrator that there is enough bandwidth available. See also the online help. Check in the AMC Control Panel (H.264 tab) that video processing is set to Decode all frames possible. Lower the image resolution.
Why do I not get 30 frames per second?	See the section <i>Optimizing your system</i> , on page 42.
Image degeneration	Decrease the GOV length, see the online help for more information.
The Status and Network indicator LEDs are flashing red rapidly	
Hardware failure	Contact your Axis reseller.
The Status indicator LED is flashing red and the encoder is inaccessible	
A firmware upgrade has been interrupted or the firmware has otherwise been damaged	See the <i>Emergency Recovery Procedure</i> above.
No images displayed on web page	
Problem with AXIS Media Control (<i>Internet Explorer only</i>)	To enable the updating of video images in Internet Explorer, set your browser to allow ActiveX controls. Also, make sure that AXIS Media Control is installed on your workstation.
Installation of additional ActiveX component restricted or prohibited	Configure your encoder to use a Java applet for updating the video images under Live View Config > Layout > Default Viewer for Internet Explorer. See the online help for more information.
Video/Image problems, general	
Image too dark or too light	Check the video image settings. See the online help on Video Stream and Camera Settings.
Missing images in uploads	This can occur when trying to use a larger image buffer than is actually available. Try lowering the frame rate or the upload period.
Slow image update	Configuring pre-buffers, motion detection, high-resolution images or high frame rates will affect the performance of the encoder.
Poor performance	Poor performance may be caused by heavy network traffic, multiple users accessing the unit, low performance clients, use of features such as motion detection, event handling, image rotation other than 180 degrees.
503 service unavailable	This error occurs when a user requests Motion JPEG or H.264 video at the same time as another user is accessing video using the same video format but with a different stream configuration. The AXIS M7001 Video Encoder supports one Motion JPEG and one H.264 stream, with different configurations, at a time.
Poor quality snapshot images	
Screen incorrectly configured on your workstation	In Display Properties, configure your screen to show at least 65000 colors, that is, at least 16-bit. Using only 16 or 256 colors will produce dithering artifacts in the image.
Browser freezes	
Older browsers	Update your browser and Java to latest versions.
Problems uploading files	
Limited space	There is only limited space available for the upload of your own files. Try deleting one or more existing files to free up space.
Motion Detection triggers unexpectedly	
Changes in luminance	Motion detection is based on changes in luminance in the image. This means that if there are sudden changes in the lighting, motion detection may be triggered mistakenly. Lower the sensitivity setting to avoid problems with luminance.

For further assistance, please contact your reseller or see the support pages on the Axis website at www.axis.com/techsup

Technical Specifications

Item	Specification
Video compression	<ul style="list-style-type: none"> • H.264 • Motion JPEG
Resolutions	NTSC: 720x480 to 176x120 PAL: 720x576 to 176x144
Frame rate H.264	30/25 (NTSC/PAL) fps in all resolutions
Frame rate Motion JPEG	30/25 (NTSC/PAL) fps in all resolutions
Video streaming	<ul style="list-style-type: none"> • Simultaneous H.264 and Motion JPEG streams in maximum resolution at 30/25 fps • Controllable frame rate and bandwidth • VBR/CBR H.264
Image settings	<ul style="list-style-type: none"> • Compression, color, brightness, contrast • Rotation: 90°, 180°, 270° • Aspect ratio correction • Mirroring of images • Text overlay • Privacy mask • Deinterlace filter
Pan/Tilt/Zoom	<ul style="list-style-type: none"> • Wide range of analog PTZ cameras supported (drivers available for download at www.axis.com) • 20 presets, guard tour, PTZ control queue • Supports Windows compatible joysticks
Users	20 simultaneous viewers
Security	Password protection, IP address filtering, HTTPS encryption, digest authentication, user access log
Supported protocols	<ul style="list-style-type: none"> • IPv4/v6, HTTP, HTTPS, QoS layer 3 DiffServ, FTP, SMTP, Bonjour, UPnP, SNMPv1/v2c/v3(MIB-II), DNS, DynDNS, NTP, RTSP, RTP, TCP, UDP, IGMP, RTCP, ICMP, DHCP, ARP, SOCKS, etc. • SSL/TLS* *This product includes software developed by the Open SSL Project for use in the Open SSL Tool kit (www.openssl.org)
Application Programming Interface	<ul style="list-style-type: none"> • Open API for software integration, including VAPIX® from Axis Communications*, AXIS Media Control SDK*, event trigger data in video stream • Quality of Service (QoS) layer 3, DiffServ Model • Embedded Linux operating system *Available at www.axis.com
Alarm triggers	Video motion detection
Alarm events	<ul style="list-style-type: none"> • File upload via FTP, HTTP and email • Notification via email, HTTP and TCP • PTZ presets
Video buffer	20 MB pre- and post-alarm
Video access from web browser	<ul style="list-style-type: none"> • Camera live view • Video recording to file (ASF) • Customizable HTML pages • Windows 7, Windows XP, 2000, 2003 server • DirectX 9c or higher • For other operating systems and browsers see www.axis.com/techsup
Processor and memory	ARTPEC-3, 64 MB RAM, 128 MB Flash
Power	Power over Ethernet IEEE 802.3af Class 2
Connectors	<ul style="list-style-type: none"> • Analog composite video BNC input, NTSC/PAL auto-sensing • RJ-45 10BaseT/100BaseTX PoE • 2.5 mm analog composite video tele plug input • RS-485/ RS-422

Item	Specification
Operating conditions	<ul style="list-style-type: none"> • 0-50 °C (32-122 °F) • Humidity 20-80% RH (non-condensing)
Approvals	EN 55022 Class B, EN 61000-3-2, EN 61000-3-3, EN 55024, EN 61000-6-1, EN 61000-6-2, FCC Part 15 Subpart B Class B, ICES-003 Class B, VCCI Class B, C-tick AS/NZS CISPR 22, EN 60950-1
Dimensions (HxWxD)	30 x 37 x 101 mm (1.2" x 1.5" x 4.0")
Weight	82 g (0.2 lb)
Included accessories	<ul style="list-style-type: none"> • Mounting and connector kits • Installation Guide • CD with installation and management tools, software and User's Manual • 1 Windows decoder user license
Video management software (not incl.)	<ul style="list-style-type: none"> • AXIS Camera Station - Video management software for viewing and recording. • See www.axis.com/products/software/ for more software applications via partners.

General performance considerations

When setting up your system, it is important to consider how various settings and situations will affect performance. Some factors affect the amount of bandwidth (the bit rate) required, others can affect the frame rate, and some will affect both. If the load on the CPU reaches its maximum, this will also affect the frame rate.

The following factors are among the most important to consider:

- High image resolutions and/or lower compression levels result in larger images. Bandwidth affected.
- Access by large numbers of Motion JPEG and/or unicast H.264 clients. Bandwidth affected.
- Simultaneous viewing of different streams (resolution, compression, etc.) by different clients. Bandwidth affected.
- Heavy usage of event settings affects the CPU load. Frame rate affected.
- Heavy network utilization due to poor infrastructure. Bandwidth affected
- Viewing on poorly performing client PC lowers perceived performance. Frame rate affected.

Optimizing your system

To see the bandwidth and frame rate currently required by the video stream, the video encoder provides a tool that can be used to display these values directly in the video image.

To do this, special format strings are added as part of a text overlay. Simply add **#r** (average frame rate in fps) and/or **#b** (average bandwidth in Kbps) to the overlay.

For detailed instructions, please see the online help for **Video & Image > Text Overlay Settings**, and the help for **File Naming & Date/Time Formats**.

Text Overlay Settings

Include date Include time

Include text:

Place text/date/time at top of image

Important!

- The figures displayed here are the values as delivered by the server. If other restrictions are currently in force, (e.g. bandwidth limitation) these values might not correspond to those actually received by the client.
- For Motion JPEG, these values will only be accurate as long as no frame rate limit has been specified.

Glossary

Active Speaker – a speaker with a built-in power amplifier.

ActiveX – A control (or set of rules) used by a browser. ActiveX controls are often downloaded and installed automatically as required.

Advanced Audio Coding (AAC) – is an audio codec that is at the core of the MPEG-4, 3GPP and 3GPP2 specifications, and is used for Internet, wireless and digital broadcast audio. AAC combines high quality audio encoding with a small file size.

AMC – AXIS Media Control. The control required for viewing video images in Internet Explorer. Installs automatically on first use.

API – Application Programming Interface. The Axis API can be used for integrating Axis products into other applications.

ARP – Address Resolution Protocol. Used to associate an IP address to a hardware MAC address. A request is broadcast on the local network to find out what the MAC address is for the IP address.

ARTPEC – Axis Real Time Picture Encoder – used for image compression.

Aspect ratio – A ratio of width to height in images. A common aspect ratio used for television screens and computer monitors is 4:3. High-definition television (HDTV) uses an aspect ratio of 16:9.

BOOTP – A protocol that can automatically configure a network device (give it an IP address).

Bonjour – Also known as zero-configuration networking, Bonjour enables automatic discovery of computers, devices, and services on IP networks. Bonjour allows devices to automatically discover each other without the need to enter IP addresses or configure DNS servers. Bonjour is developed by Apple Computer Inc.

CGI – Common Gateway Interface. A set of rules (or a program) that allows a Web Server to communicate with other programs.

Client/Server – Describes the network relationship between two computer programs, in which one, the client, makes a service request from another – the server.

DC-Iris – This special type of iris is electrically controlled by the Axis camera, to automatically regulate the amount of light allowed to enter.

dB (Decibels) – A unit to measure sound level changes. A 3dB change is the smallest level change we can hear. A 3dB change is actually twice or half the audio power level. A gain of 0dB will leave the signal level unchanged.

De-interlacing – De-interlacing is the process taking a stream of interlaced frames and converting it to a stream of progressive frames.

DSL – Digital Subscriber Line. A means of transferring data via standard phone lines.

Ethernet – A widely used networking standard.

ETRAX – Axis' own microprocessor.

Firewall – A virtual barrier between a LAN (Local Area Network) and other networks, e.g. the Internet.

FTP – File Transfer Protocol. Used for the simple transfer of files to and from an FTP-server.

Full-duplex – Transmission of data, e.g. audio, in two directions simultaneously.

G.711 – G.711 is the international standard for encoding

telephone audio on 64 kbps channel. It is a pulse code modulation (PCM) scheme operating at 8 kHz sample rate.

G.726 – Frequently used speech-compression algorithm in telecommunications due to its high perceived speech quality and low resource requirements.

H.264 – Also known as MPEG-4 Part 10. This is the new generation compression standard for digital video. H.264 offers higher video resolution than Motion JPEG or MPEG-4 at the same bit rate and bandwidth, or the same quality video at a lower bit rate.

Half-duplex – A half-duplex link communicates in one direction at a time only, much like a walkie-talkie. Two way communication is possible, but not simultaneously.

HTTP – Hypertext Transfer Protocol. The set of rules for exchanging files (text, images, sound, video, and other files) on the World Wide Web.

HTTPS – An extension to the HTTP protocol to support sending data securely over the World Wide Web.

Intranet – A private network limited to an organization or corporation. Usually closed to external traffic.

IP – Internet Protocol. See TCP/IP.

IP address – A unique number used by a computer on the network to allow it to be identified and found.

ISMA – Internet Streaming Media Alliance.

JPEG – A standard image format, used widely for photographs. Also known as JPG.

LAN – A local area network (LAN) is a group of computers and associated devices that typically share common resources within a limited geographical area.

Linux – A popular operating system that is "open source" and practically free of charge.

Local storage – If a camera or video encoder supports local storage, an SD card can be inserted into the SD card slot to locally record and store a video stream.

Lux – A standard unit for light measurement.

Mbit/s – Megabits per second. A unit for measuring speeds in networks. A LAN might run at 10 or 100 Mbit/s.

Motion JPEG – Delivers a high quality video stream, from which individual images can be extracted and saved.

MPEG-4 – A video compression standard that makes good use of bandwidth, and which can provide DVD-quality video streams at less than 1 Mbit/s.

Multicast – A bandwidth-conserving technology that reduces bandwidth usage by simultaneously delivering a single stream of information to multiple network recipients.

PEM – Privacy Enhanced Mail. An early standard for securing electronic mail. The PEM-format is often used for representing an HTTPS certificate or certificate request.

Ping – A small utility used for sending data packets to network resources to check that they are working and that the network is intact.

Pre/post alarm image – The images from immediately before and after an alarm.

Protocol – A special set of rules governing how two entities will communicate. Protocols are found at many levels of communication, and there are hardware protocols and software protocols.

(QoS) Quality of Service – QoS provides the means to guarantee a certain level of a specified resource to selected traffic on a network. Quality can be defined as e.g. a maintained level of bandwidth, low latency, no packet losses, etc.

Router – A device that determines the next network point to which a packet should be forwarded on its way to its final destination. A router is often included as part of a network switch (see below).

RTP – Real-Time Transfer Protocol. A transfer protocol designed for the delivery of live content, e.g. H.264.

RTSP (Real Time Streaming Protocol) – RTSP is a control protocol, and a starting point for negotiating transports such as RTP, multicast and Unicast, and for negotiating codecs. RTSP can be considered a "remote control" for controlling the media stream delivered by a media server. RTSP servers typically use RTP as the protocol for the actual transport of audio/video data.

Simplex – In simplex operation, a network cable or communications channel can only send information in one direction; it's a "one-way street".

SMTP – Simple Mail Transfer Protocol is the protocol used to send email across the Internet. SMTP authentication is a way of allowing people outside of a domain to use an SMTP server when sending email.

SNMP – Simple Network Management Protocol. An application layer protocol that facilitates the exchange of management information between network devices. It is part of the Transmission Control Protocol/Internet Protocol (TCP/IP) protocol suite.

Subnet Mask – An IP address consists of two components: the network address and the host address. "Subnetting" enables a network administrator to further divide the host part of the address into two or more subnets. The subnet mask identifies the subnet to which an IP address belongs.

Switch – A network switch is a device used to connect multiple devices to the network. A switch only transmits data to the device the data is specially intended for.

TCP/IP – Transmission Control Protocol/Internet Protocol. A suite of network protocols that determine how data is transmitted. TCP/IP is used on many networks, including the Internet. TCP keeps track of the individual packets of information and IP contains the rules for how the packets are actually sent and received.

UDP – The User Datagram Protocol is a communications protocol that offers a limited amount of service when messages are exchanged between computers in a network that uses the Internet Protocol (IP). UDP is an alternative to the Transmission Control Protocol (TCP) and, together with IP, is also known as UDP/IP.

Unicast – Communication between a single sender and a single receiver over a network. A new connection is established for each new user.

URL – Uniform Resource Locator. An "address" on the network.

Varifocal – A varifocal lens provides a wide range of focal lengths, as opposed to a lens with a fixed focal length, which only provides one.

WAN – Wide-Area-Network. Similar to a LAN, but on a larger geographical scale.

Web server – A program on a computer that delivers the resources (usually web pages) requested by the web user (the client).

Index

A

Absolute PTZ driver 25
 Action 16
 Action buttons 8, 15
 Administrator 11
 Alarm 19
 AMC Control Panel 10
 ARP/Ping 29
 AXIS Media Control (AMC) 6, 10

B

Bit rate 12
 Bonjour 6
 Buffer 17
 Buffer size 17

C

CGI links 15, 26
 Click-in-image 26
 COM Port 32
 Constant bit rate 12
 Control button 34
 Control panel 23, 26
 Control queue 24, 26

D

Date & Time 28
 Default viewer 14
 DNS Configuration 29
 DNS Server 29
 Domain name 29

E

Emergency recovery 37
 Enable ARP/Ping 29
 Event server 16
 Events 16

F

Factory default settings 34
 Frame rate 11
 FTP Server 16

G

GOV Settings 11

H

H.264 6, 9, 11
 Host name 30
 HTTP Server 16
 HTTPS 7, 27

I

Installing PTZ devices 21
 IP address filtering 27

L

LED indicators 5
 LED Settings 32
 Live View Config 14

M

Motion detection 19
 Motion JPEG 6, 9

N

NAT traversal 7, 30
 Network settings 28
 NTP Server 28

O

OSD Menu 23

P

Pan/Tilt/Zoom 25
 Post-trigger buffer 17
 Preset positions 22
 Pre-trigger buffer 17
 Privacy mask 13
 PTZ commands 26
 PTZ control panel 23, 26
 PTZ control queue 24, 26

Q

QoS (Quality of Service) 31
 QuickTime 10, 14

R

Recovery 37
 Relative PTZ driver 25
 Restart 32
 Restore 32

S

Scheduled event 16, 18
Security 27
Server time 28
SMTP (email) 31
SNMP 32
SOCKS 31
Stream profile 12, 14
Support 33
System Options 27

T

TCP Server 16
TCP/IP Settings 28
Technical specifications 41
Time mode 28
Triggered event 16, 17
Troubleshooting 37

U

Upgrade Server 33
UPnP 30, 32
Users 27

V

VAPIX 13, 15, 21
Variable bit rate 12
Video streams 9, 11